

Schottky Barrier Rectifiers

Features

- Low Forward Voltage Drop
- Guard Ring Construction for Transient Protection
- High Conductance
- Also Available in Lead Free Version

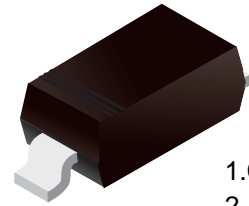

1.Cathode
2.Anode

Simplified outline(SOD-123)



Maximum Ratings and Electrical characteristics

Ratings at 25 °C ambient temperature unless otherwise specified.

Parameter	Symbols	MBR0520W	MBR0530W	MBR0540W	Units
Peak Repetitive Reverse Voltage	V_{RRM}	20	30	40	V
RMS reverse voltage reverse voltage (DC)	V_{RMS}	14	21	28	V
Maximum DC Blocking Voltage	V_{DC}	20	30	40	V
Maximum Average Forward Current at Ta=25°C	I_O	0.5			A
Peak Forward Surge Current, 8.3ms single half sine-wave superimposed on rated load (JEDEC method)	I_{FSM}	25			A
Maximum Instantaneous Forward Voltage	$I_F=0.1A$	0.330	0.375	–	V
	$I_F=0.5A$	0.390	0.430	0.510	
	$I_F=1A$	–	–	0.620	
Reverse current	$V_R=10V$	75	–	–	uA
	$V_R=15V$	–	20	–	
	$V_R=20V$	250	–	10	
	$V_R=30V$	–	130	–	
	$V_R=40V$	–	–	20	
Thermal Resistance, Junction to Ambient Air	$R_{\theta JA}$	200			°C/W
Junction temperature	T_j	-55 ~ +125			°C
Storage temperature	T_{stg}	-55 ~ +150			°C

Marking

Type	MBR0520W	MBR0530W	MBR0540W
Marking	B2	B3	B4

Fig.1 Forward Current Derating Curve

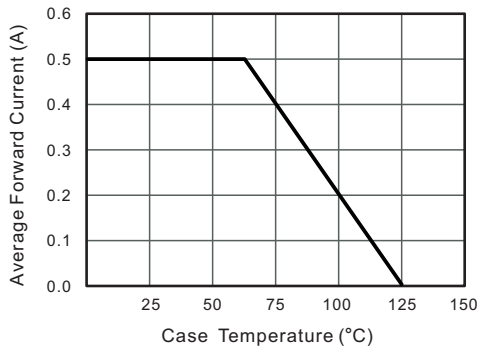

Fig.2 Typical Reverse Characteristics

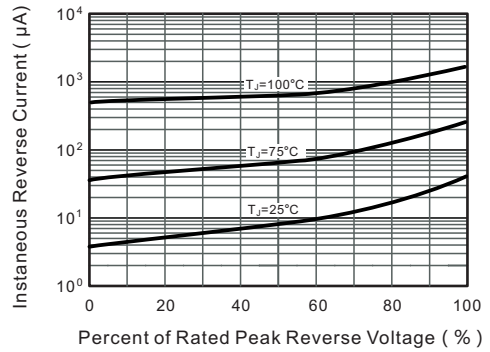

Fig.3 TYPICAL FORWARD VOLTAGE

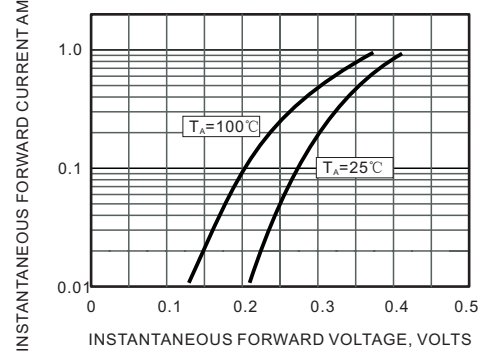

Fig.4 Typical Junction Capacitance

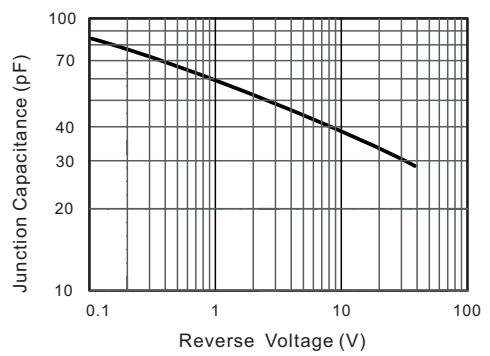

Fig.5 Maximum Non-Repetitive Peak Forward Surge Current

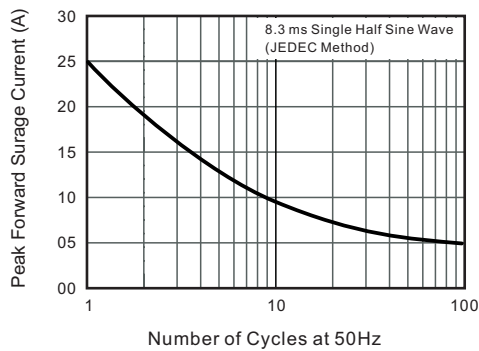
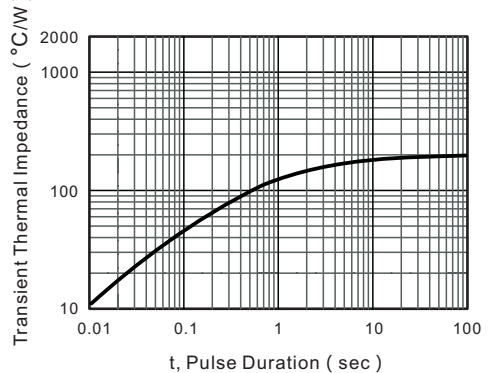
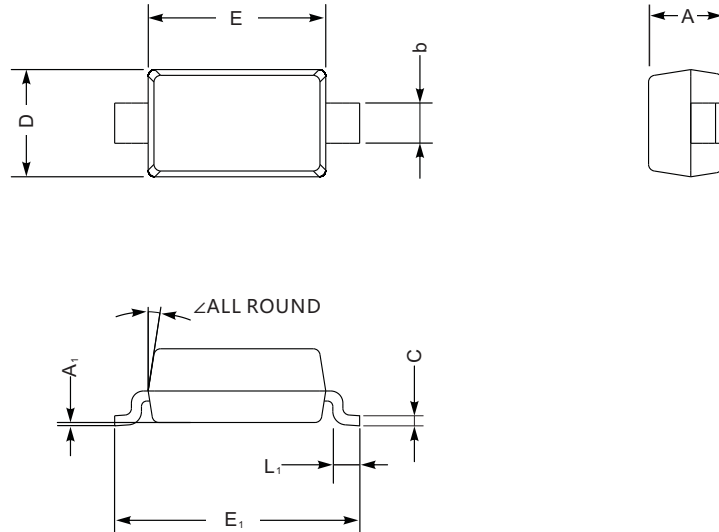

Fig.6 Typical Transient Thermal Impedance



■ SOD-123



SOD-123 mechanical data

UNIT		A	C	D	E	E ₁	L ₁	b	A ₁	∠
mm	max	1.3	0.22	1.8	2.8	3.9	0.45	0.7	0.2	9°
	min	0.9	0.09	1.5	2.5	3.6	0.25	0.5	—	
mil	max	51	8.7	71	110	154	18	28	8	
	min	35	3.5	59	98	142	10	20	—	

■ The recommended mounting pad size

